

VACUUM SUCTION CUP

PAF

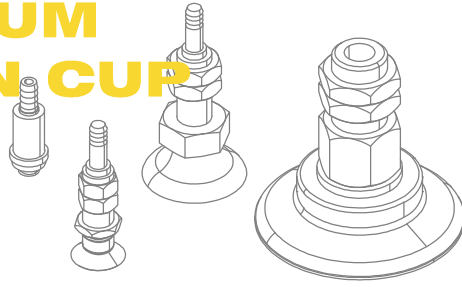

PDF

2D



DA-E

PNEUMATIC HYDRAULIC CO.,LTC

Ø5 ~ Ø8

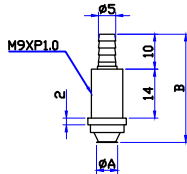

型號	盤徑 A	總長 B	配合尺寸
PAF-05	Ø5	30.5	PU管 Ø6X4
PAF-06	Ø6	31	
PAF-08	Ø8	31	

Ø10 ~ Ø15

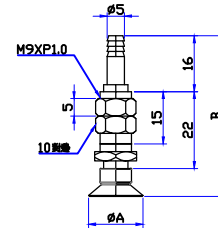

型號	盤徑 A	總長 B	配合尺寸
PAF-10	Ø10	46	PU管 Ø6X4
PAF-15	Ø15	46	

Ø20 ~ Ø50

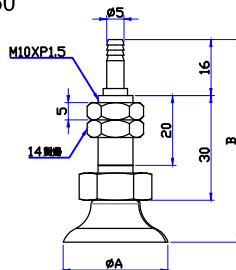

型號	盤徑 A	總長 B	配合尺寸
PAF-20	Ø20	56	PU管 Ø6X4
PAF-25	Ø25	60	
PAF-30	Ø30	58	
PAF-35	Ø35	60	
PAF-40	Ø40	60	
PAF-50	Ø50	61	

Ø60

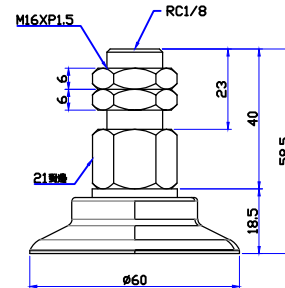

Ø80

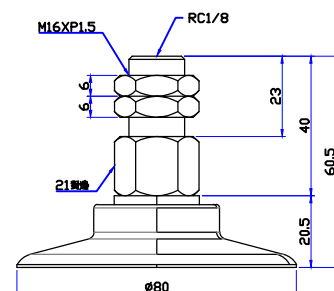

VACUUM SUCTION CUP

PBF

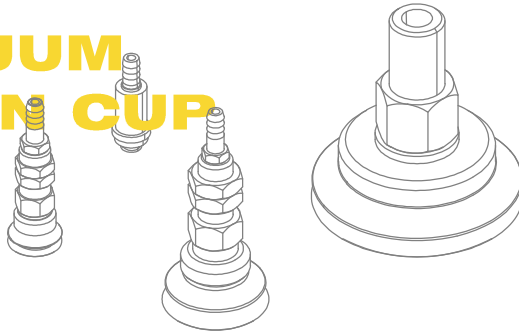

PDF

2D



DA-E

PNEUMATIC HYDRAULIC CO.,LTC

∅6 ~ ∅8

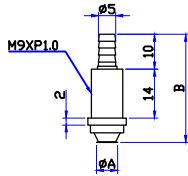

型號	盤徑 A	總長 B	配合尺寸
PBF-06	∅6	33	PU管 ∅6X4
PBF-08	∅8	33	

∅10 ~ ∅15

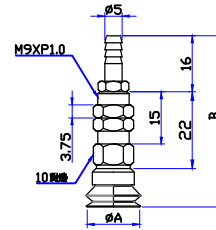

型號	盤徑 A	總長 B	配合尺寸
PBF-10	∅10	47.5	PU管 ∅6X4
PBF-15	∅15	49	

∅20 ~ ∅50

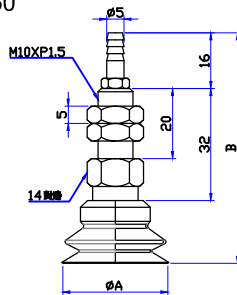

型號	盤徑 A	總長 B	配合尺寸
PBF-20	∅20	61	PU管 ∅6X4
PBF-25	∅25	62	
PBF-30	∅30	66	
PBF-35	∅35	66	
PBF-40	∅40	66	
PBF-50	∅50	68	

∅60

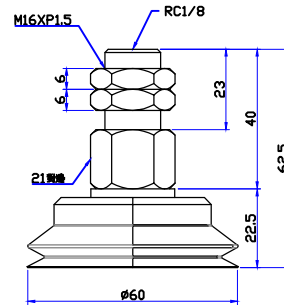

∅80

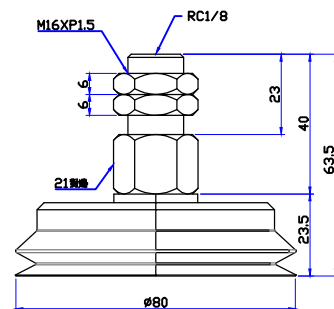

VACUUM SUCTION CUP

PAT

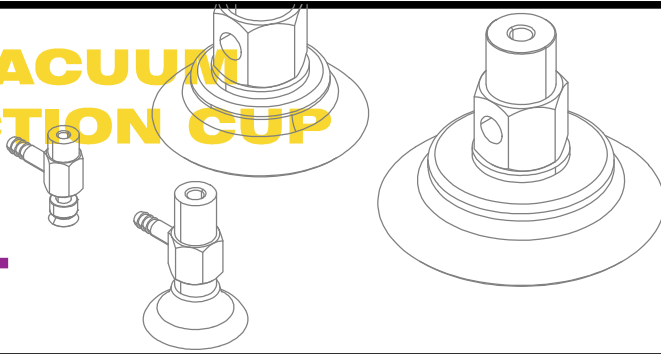

PDF

2D



DA-E

PNEUMATIC HYDRAULIC CO.,LTC

Ø6 ~ Ø15

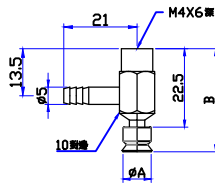

型號	盤徑 A	總長 B	配合尺寸
PAT-05	Ø5	29	PU管 Ø6X4
PAT-06	Ø6	29	
PAT-08	Ø8	29.5	
PAT-10	Ø10	30	
PAT-15	Ø15	30	

Ø20 ~ Ø50

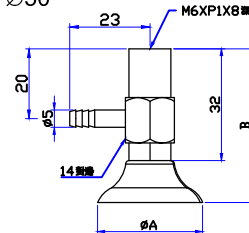

型號	盤徑 A	總長 B	配合尺寸
PAT-20	Ø20	42	PU管 Ø6X4
PAT-25	Ø25	46	
PAT-30	Ø30	44	
PAT-35	Ø35	46	
PAT-40	Ø40	46	
PAT-50	Ø50	47	

PAT-60

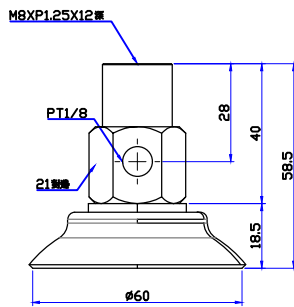

PAT-80

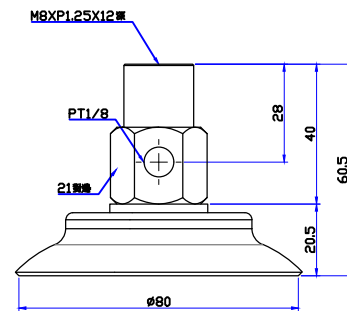

VACUUM SUCTION CUP

PBT

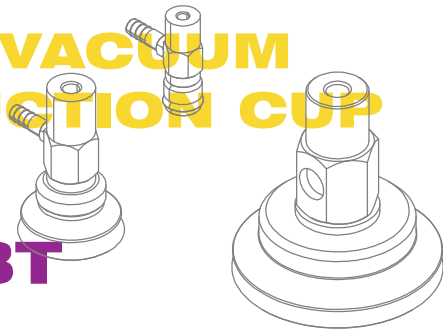

PDF

2D



DA-E

PNEUMATIC HYDRAULIC CO.,LTC

Ø6 ~ Ø15

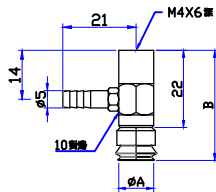

型號	盤徑 A	總長 B	配合尺寸
PBT-06	Ø6	31.5	PU管 Ø6X4
PBT-08	Ø8	31.5	
PBT-10	Ø10	31.5	
PBT-15	Ø15	33	

Ø20 ~ Ø50

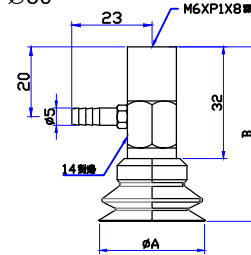

型號	盤徑 A	總長 B	配合尺寸
PBT-20	Ø20	45	PU管 Ø6X4
PBT-25	Ø25	47	
PBT-30	Ø30	50	
PBT-35	Ø35	50	
PBT-40	Ø40	50	
PBT-50	Ø50	52	

PBT-60

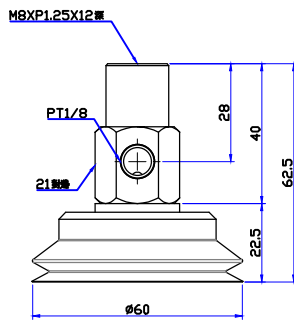

PBT-80

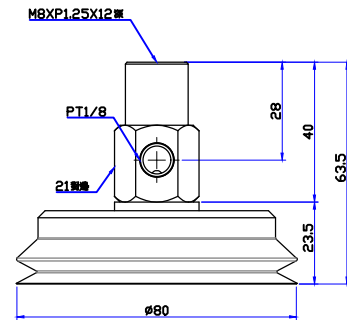

VACUUM SUCTION CUP

PAFS

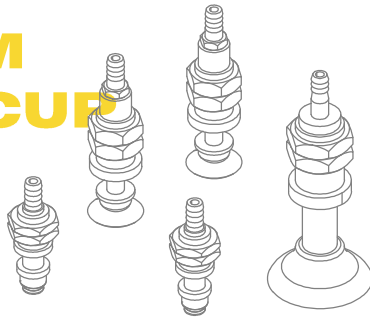

PDF

2D



DA-E

PNEUMATIC HYDRAULIC CO.,LTC

∅5 ~ ∅8

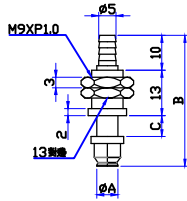

型號	盤徑 A	行程3MM		行程10MM		配合尺寸
		B	C	B	C	
PAFS-05	∅5	37.5	6	51.5	20	PU管 ∅6X4
PAFS-06	∅6	37.5	6	51.5	20	
PAFS-08	∅8	38	6	52	20	

∅10 ~ ∅15

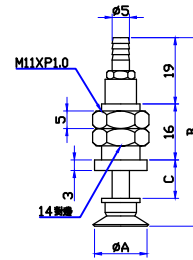

型號	盤徑 A	行程4MM		行程10MM		配合尺寸
		B	C	B	C	
PAFS-10	∅10	56.5	8	68.5	20	PU管 ∅6X4
PAFS-15	∅15	54	8	66	20	

∅20 ~ ∅50

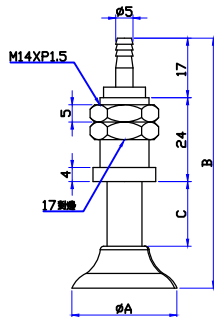

型號	盤徑 A	行程6MM		行程15MM		配合尺寸
		B	C	B	C	
PAFS-20	∅20	69.5	13	86.5	30	PU管 ∅6X4
PAFS-25	∅25	73.5	13	90.5	30	
PAFS-30	∅30	71.5	13	88.5	30	
PAFS-35	∅35	73.5	13	90.5	30	
PAFS-40	∅40	71	13	88	30	
PAFS-50	∅50	72	13	89	30	

VACUUM SUCTION CUP

PBFS

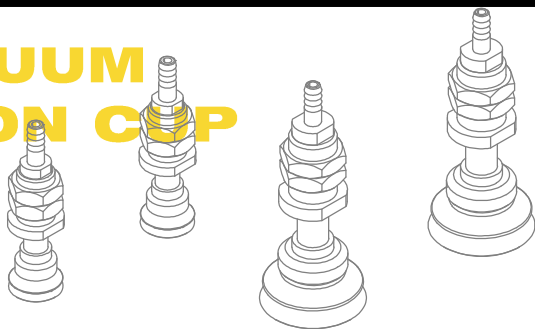

PDF 2D



DA-E

PNEUMATIC HYDRAULIC CO.,LTC

∅6 ~ ∅8

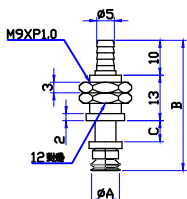

型號	盤徑 A	行程3MM		行程10MM		配合尺寸
		B	C	B	C	
PBFS-06	∅6	40	5.5	54	15	PU管
PBFS-08	∅8	40	5.5	54	15	∅6X4

∅10 ~ ∅15

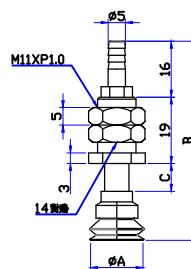

型號	盤徑 A	行程4MM		行程10MM		配合尺寸
		B	C	B	C	
PBFS-10	∅10	55.5	8	67.5	20	PU管
PBFS-15	∅15	57	8	69	20	∅6X4

∅20 ~ ∅50

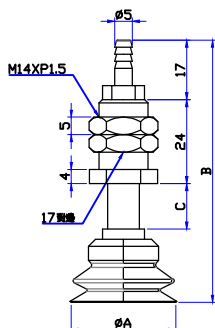

型號	盤徑 A	行程6MM		行程15MM		配合尺寸
		B	C	B	C	
PBFS-20	∅20	69	13	82	30	PU管 ∅6X4
PBFS-25	∅25	73	13	90	30	
PBFS-30	∅30	75	13	92	30	
PBFS-35	∅35	75	13	92	30	
PBFS-40	∅40	75	13	92	30	
PBFS-50	∅50	77	13	94	30	

VACUUM SUCTION CUP

PATS

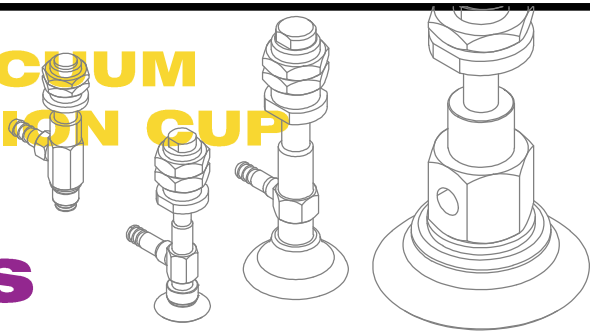

PDF

2D



DA-E

PNEUMATIC HYDRAULIC CO.,LTC

Ø5 ~ Ø8

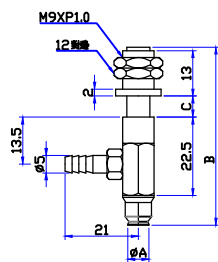

Ø10 ~ Ø15

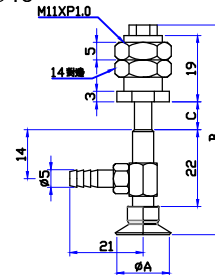

型號	盤徑 A	行程3MM		行程10MM		配合尺寸
		B	C	B	C	
PATS-05	Ø5	51	6	65	20	PU管 Ø6X4
PATS-06	Ø6	51	6	65	20	
PATS-08	Ø8	51.5	6	65.5	20	

型號	盤徑 A	行程4MM		行程10MM		配合尺寸
		B	C	B	C	
PATS-10	Ø10	60	8	72	20	PU管 Ø6X4
PATS-15	Ø15	60	8	72	20	

Ø20 ~ Ø50

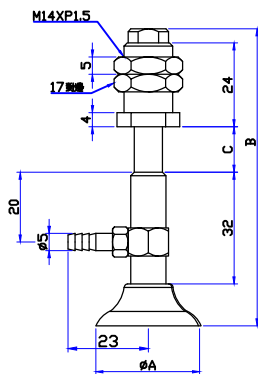

Ø60 ~ Ø80

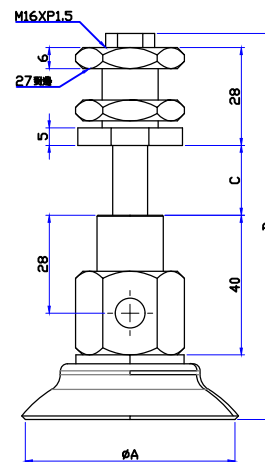

型號	盤徑 A	行程6MM		行程15MM		配合尺寸
		B	C	B	C	
PATS-20	Ø20	83	13	96	30	PU管 Ø6X4
PATS-25	Ø25	87	13	104	30	
PATS-30	Ø30	85	13	102	30	
PATS-35	Ø35	87	13	104	30	
PATS-40	Ø40	87	13	104	30	
PATS-50	Ø50	88	13	105	30	

型號	盤徑 A	行程10MM		行程30MM		配合尺寸
		B	C	B	C	
PATS-60	Ø60	111	20	151	60	1/8牙
PATS-80	Ø80	113	20	153	60	

VACUUM SUCTION CUP

PBTS

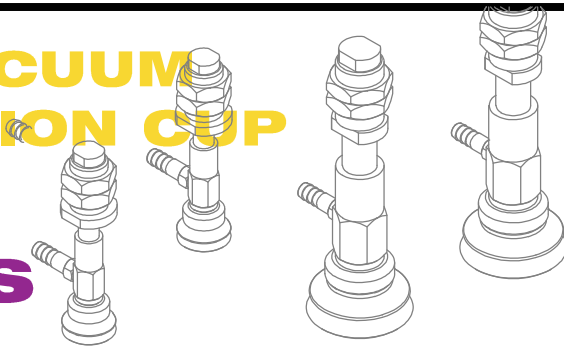

PDF

2D



DA-E

PNEUMATIC HYDRAULIC CO.,LTC

Ø10 ~ Ø15

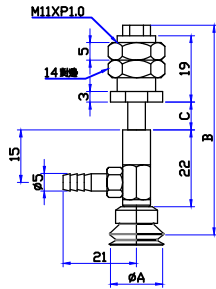

型號	盤徑 A	行程4MM		行程10MM		配合尺寸
		B	C	B	C	
PBTS-10	Ø10	61.5	8	73.5	20	PU管
PBTS-15	Ø15	63	8	75	20	Ø6X4

Ø20 ~ Ø50

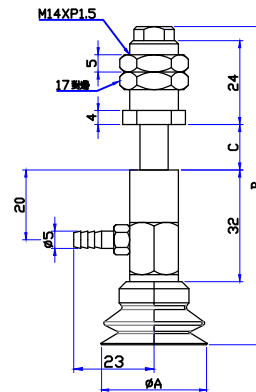

型號	盤徑 A	行程6MM		行程15MM		配合尺寸
		B	C	B	C	
PBTS-20	Ø20	83	13	96	30	PU管 Ø6X4
PBTS-25	Ø25	90	13	105	30	
PBTS-30	Ø30	91	13	108	30	
PBTS-35	Ø35	91	13	108	30	
PBTS-40	Ø40	91	13	108	30	
PBTS-50	Ø50	93	13	110	30	

Ø60 ~ Ø80

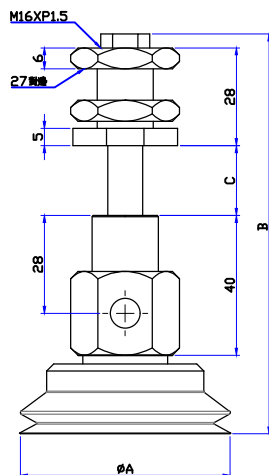

型號	盤徑 A	行程10MM		行程30MM		配合尺寸
		B	C	B	C	
PBTS-60	Ø60	115	20	155	60	1/8牙
PBTS-80	Ø80	116	20	156	60	